

# Oil and sand Separator OilBase100-20/100 (S1:25)

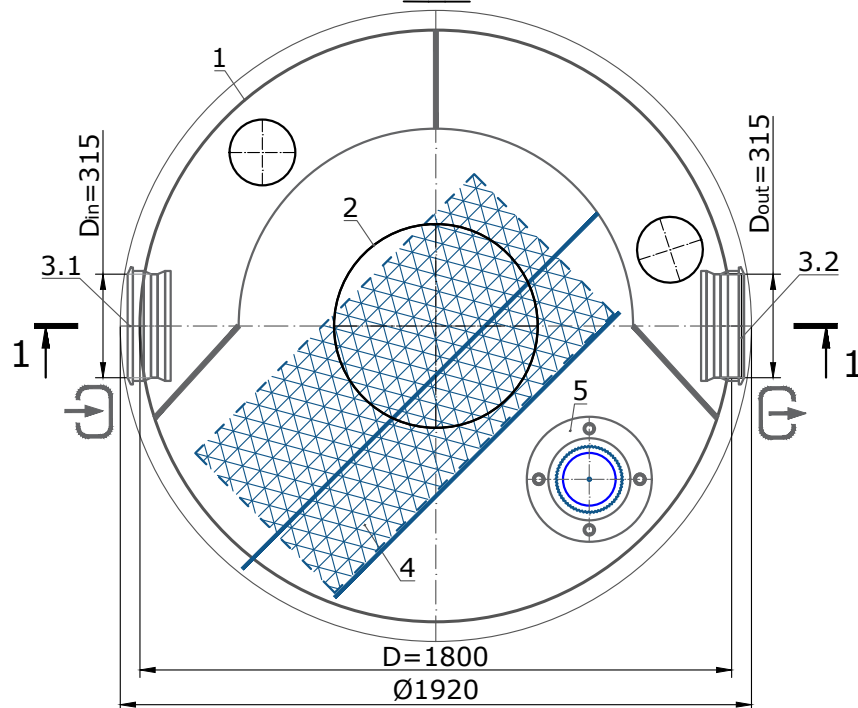

3D visualization

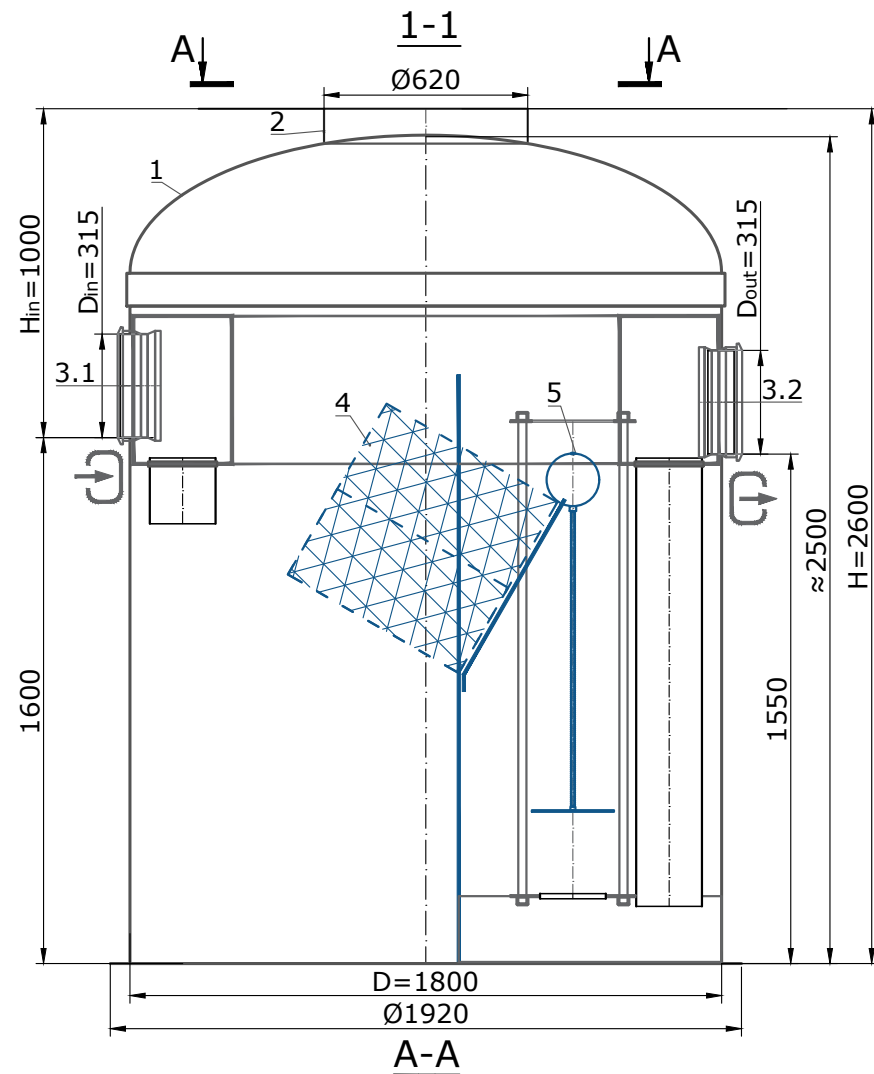
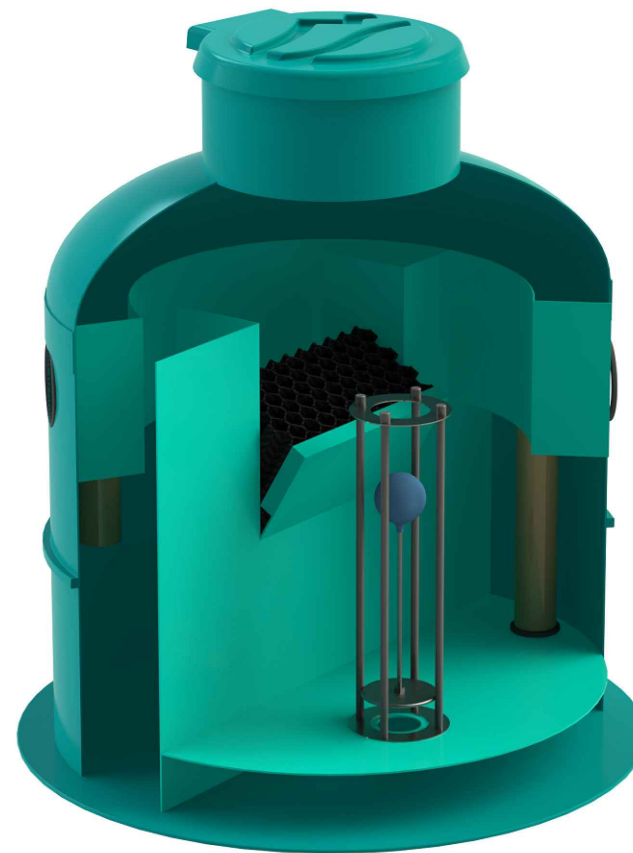

Pipe layout diagram

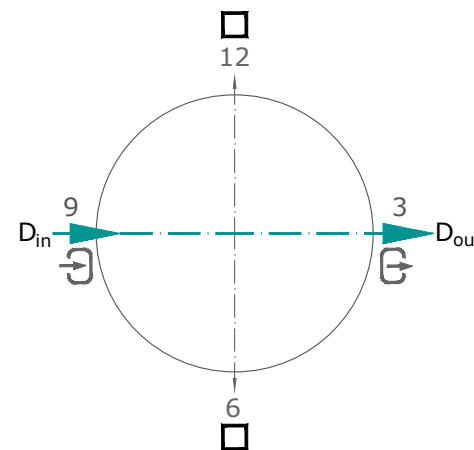







## Specification of materials and equipment. Standard equipment (Table 1)

Pos.	Name	Q-ty	Mass, kg	Note
1	Oil and sand Separator Vodaland OilBase100-20/100 with Bypass, flow rate-20 l/s, (By-Pass - 100 l/s), vertical, fiberglass, D=1800, H=2600	1	409 ±12%	compl.
2	Neck extension Ø620	1		compl.
3.1, 3.2	Rubber seal for connection PVC SN4 Ø315	2		compl.
4	Coalescent block	1		compl.
5	Automatic closure device	1		compl.
	Light liquids storage capacity	1000		L
	Silt storage capacity	2000		L
	Usable storage capacity	4300		L

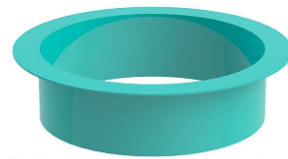
The product is shipped according to Standard Equipment (Table 1), unless otherwise specified in the Additional Equipment (Table 2)

## Additional equipment (Table 2)

<input type="checkbox"/> Fiberglass lid Ø620 	<input type="checkbox"/> Plastic manhole cover, class A 	<input type="checkbox"/> Cast manhole, class: <input type="checkbox"/> B <input type="checkbox"/> C <input type="checkbox"/> D 
<input type="checkbox"/> Fiberglass adaptor plate Ø620 	<input type="checkbox"/> Universal ladder 	<input type="checkbox"/> Neck extension Ø620: <input type="checkbox"/> h=500mm <input type="checkbox"/> h=1000mm <input type="checkbox"/> h=1500mm 
<input type="checkbox"/> Level sensor set: <input type="checkbox"/> Sludge <input type="checkbox"/> Light liquids <input type="checkbox"/> Max level 		

**Note:**

This is a standard drawing (Hin=1000mm; D; Din/Dout) that can be customized on request as individual product  
 The manufacturer reserves the right to make design and schematic changes that do not impair the characteristics of the product as a whole  
 Permissible deviation during production of products is 1-3%

**Additional Information::**

**Oil and sand Separator Vodaland  
OilBase100-20/100**



Factory ID: **OB1-20/100**

Material: reinforced fiberglass

Date: 05/2026

