

Oil and sand Separator OilBase100-6/30 (S1:20)

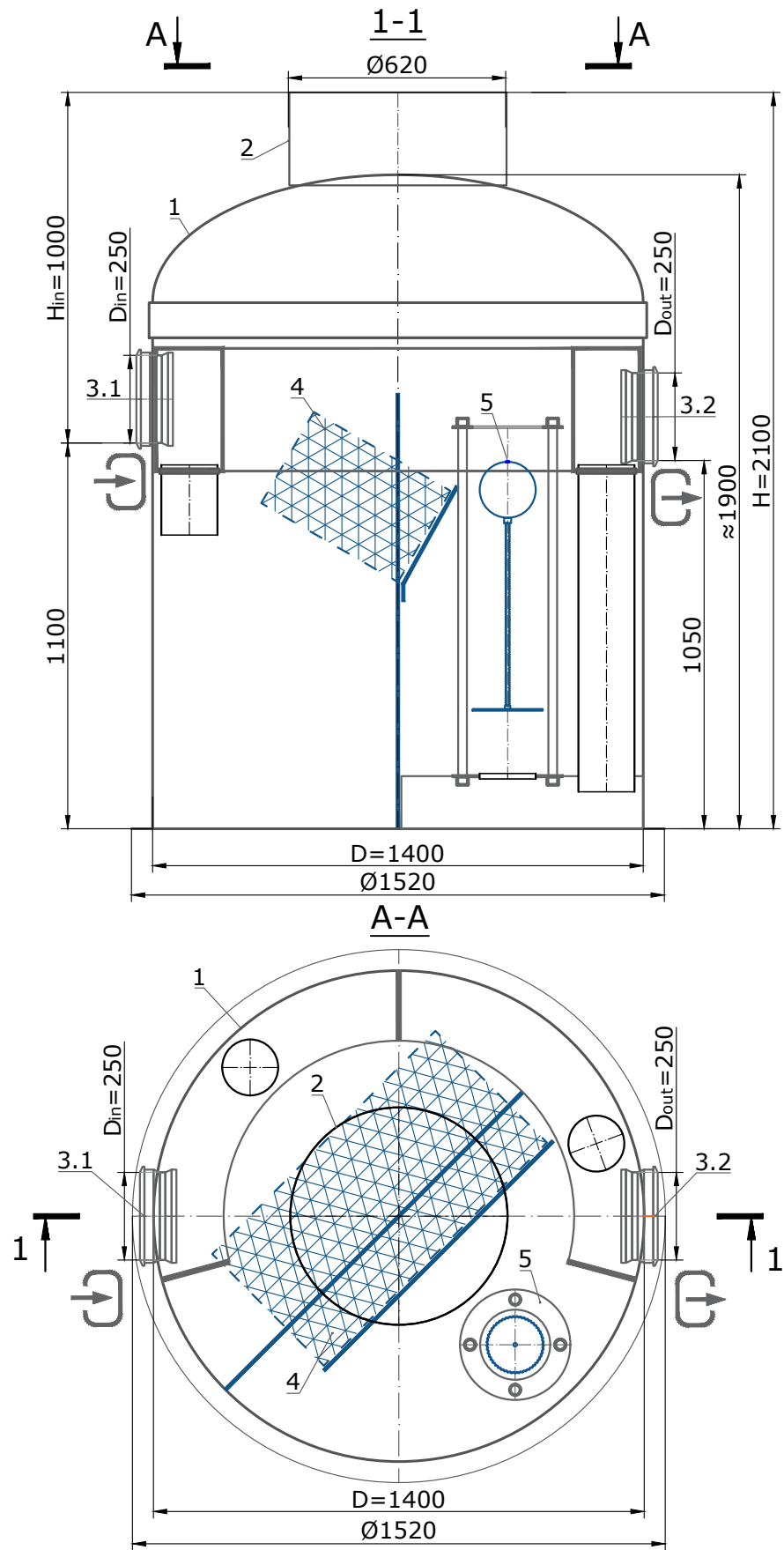

3D visualization

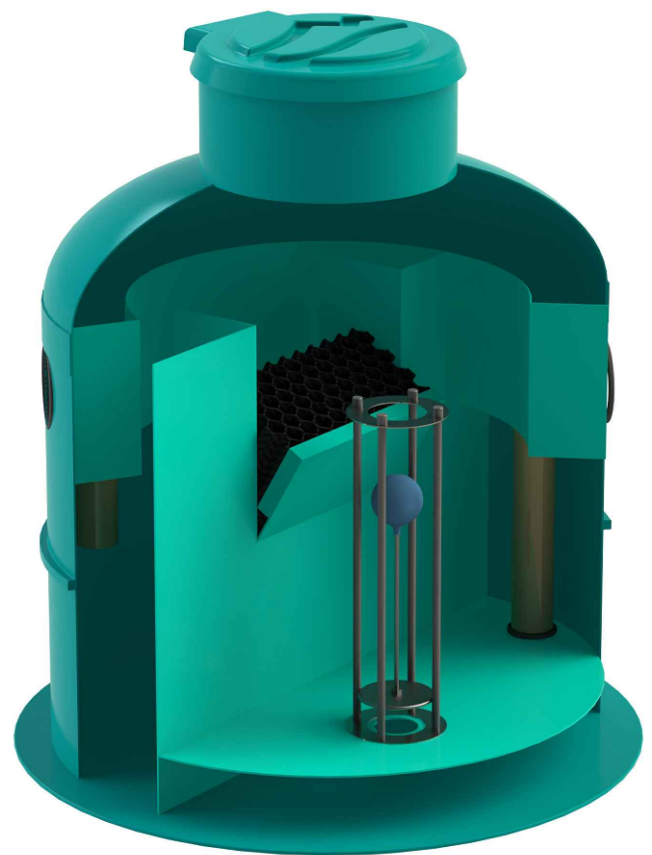

Pipe layout diagram

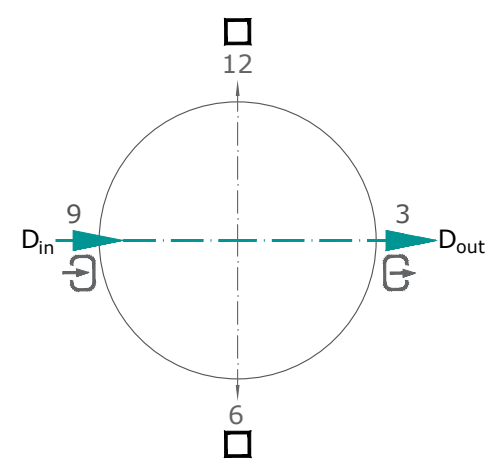







Specification of materials and equipment. Standard equipment (Table 1)

Pos.	Name	Q-ty	Mass, kg	Note
1	Oil and sand Separator Vodaland OilBase100-6/30 with Bypass, flow rate-6 l/s, (By-Pass - 30 l/s), vertical, fiberglass, D=1400, H=2100	1	251 ±12%	compl.
2	Neck extension Ø620	1		compl.
3.1, 3.2	Rubber seal for connection PVC SN4 Ø250	2		compl.
4	Coalescent block	1		compl.
5	Automatic closure device	1		compl.
	Light liquids storage capacity	300		L
	Silt storage capacity	600		L
	Usable storage capacity	1850		L

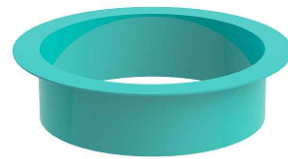
The product is shipped according to Standard Equipment (Table 1), unless otherwise specified in the Additional Equipment (Table 2)

Additional equipment (Table 2)

<input type="checkbox"/> Fiberglass lid Ø620 	<input type="checkbox"/> Plastic manhole cover, class A 	<input type="checkbox"/> Cast manhole, class: <input type="checkbox"/> B <input type="checkbox"/> C <input type="checkbox"/> D 
<input type="checkbox"/> Fiberglass adaptor plate Ø620 	<input type="checkbox"/> Universal ladder 	<input type="checkbox"/> Neck extension Ø620: <input type="checkbox"/> h=500mm <input type="checkbox"/> h=1000mm <input type="checkbox"/> h=1500mm 
<input type="checkbox"/> Level sensor set: <input type="checkbox"/> Sludge <input type="checkbox"/> Light liquids <input type="checkbox"/> Max level 		

Note:
This is a standard drawing (Hin=1000mm; D; Din/Dout) that can be customized on request as individual product
The manufacturer reserves the right to make design and schematic changes that do not impair the characteristics of the product as a whole
Permissible deviation during production of products is 1-3%

Additional Information::

Oil and sand Separator Vodaland OilBase100-6/30



Factory ID: **OB1-6/30**
Material: reinforced fiberglass Date: 05/2026

